



PL

Oprawa LED SWAY jest zewnętrzną oprawą oświetleniową montowaną na uchwycie. Może być mocowana do elewacji lub do podłoża. Istnieje możliwość wykonania na zamówienie modelu z klinem ziemnym. SWAY znajduje zastosowanie przy oświetlaniu elewacji i obiektów zewnętrznych. Występuje w kilku wariantach kąta rozsyłu światła. Oprawa może współpracować z systemem sterowania DALI.

EN

The SWAY LED fixture is an external lighting mounted on a handle. It can be mounted on the building facade or on the ground surface. It is possible to order a model with a ground mounting stake. The SWAY fixtures are used for the illumination of building facades and external objects. Several variants of light distribution angle are available. The fixture can work with the DALI control system.

DE

Die LED-Leuchte SWAY ist eine Außenleuchte, die an einer Halterung montiert wird. Sie kann an der Fassade oder am Boden montiert werden. Eine Variante mit Säule auf Anfrage möglich. SWAY findet die Anwendung zur Beleuchtung von Fassaden und Außenobjekten. Mit Abstrahlwinkel in mehreren Varianten. Die Leuchte kann mit dem DALI-System zusammenarbeiten.

OPCJE DO WYBORU / OPTIONS / OPTIONSWAHL MÖGLICH:



S



3000 K 5700K*
4000 K



biały/white/weiß
inny/different/andere*

S – szyba hartowana / tempered glass / Scheibe aus gehärtetem Glas

*Opcje dostępne na zamówienie po konsultacji z działem handlowym. / Options available on request, following consultation with the sales department. / Andere Optionen auf Bestellung nach der Beratung mit der Handelsabteilung erhältlich.

PL

PARAMETRY TECHNICZNE

Sposób montażu: natynkowy

Obudowa: aluminium

PARAMETRY ELEKTRYCZNE

Napięcie zasilania: 220-240 V / 50 Hz

Współczynnik mocy (PF): 0,99

Klasa ochronności: I

PARAMETRY UŻYTKOWE

Współczynnik oddawania barw Ra: 85

Stopień ochrony: IK07

Stopień szczelności: IP65

Temperatura otoczenia: od -25°C do +35°C

Wilgotność otoczenia: 20-80%

Trwałość (L70B50): 100 000 h

ZASTOSOWANIE: obiekty użyteczności publicznej, korytarze, parkingi i przejścia podziemne, magazyny, hale przemysłowe, elewacje

EN

TECHNICAL PARAMETERS

Mounting: surface mounting

Body: aluminium

ELECTRICAL PARAMETERS

Power Supply: 220-240 V / 50 Hz

Power factor (PF): 0,99

Protection class: I

FUNCTIONAL PARAMETERS

Color rendering index Ra: 85

Protection marking: IK07

Protection marking: IP65

Ambient temperature: from -25°C to +35°C

Ambient humidity: 20-80%

Lifetime (L70B50): 100 000 h

APPLICATION: public utility buildings, corridors, car parks and underpasses, warehouses, industrial halls, elevations

DE

TECHNISCHE DATEN

Montageart: zur Aufputz-Montage

Gehäuse: Aluminium

ELEKTRISCHE PARAMETER

Speisespannung: 220-240 V / 50 Hz

Leistungsfaktor (PF): 0,99

Schutzklasse: I

BETRIEBSPARAMETER

Farbwiedergabe Faktor Ra: 85

Schutzklasse: IK07

Schutzklasse: IP65

Umgebungstemperatur: von -25°C bis



+35°C Umgebungsluftfeuchtigkeit: 20-80%

Lebensdauer (L70B50): 100 000 h

EINSATZBEREICH: öffentliche Gebäude, Korridore, Parkplätze und Unterführungen, Lagerräume, Industriehallen, Fassaden

Deklarowana trwałość dotyczy opraw pracujących w temperaturze otoczenia 25°C przy zapewnionych optymalnych warunkach wentylacji. / The declared lifetime applies to fixtures operating at an ambient temperature of 25°C with ensured optimal ventilation conditions. / Die erklärte Lebensdauer bezieht sich auf Leuchten, die bei einer Raumtemperatur von 25°C und optimalen Lüftungsbedingungen arbeiten.

PRODUKTY / PRODUCTS / PRODUKTE:

CODE	P	Tc					DALI
------	---	----	---	--	---	---	------

		[W]	[K]		[°]	[lm]	[lm/W]	
SWAY	4000K/20W/20ST	20	4000	S	20	2100	105	-
SWAY	4000K/20W/30ST	20	4000	S	30	2350	118	-
SWAY	4000K/20W/40ST	20	4000	S	40	2350	118	-
SWAY	4000K/20W/50ST	20	4000	S	50	2350	118	-
SWAY	4000K/30W/20ST	30	4000	S	20	2900	97	-
SWAY	4000K/30W/30ST	30	4000	S	30	3200	107	-
SWAY	4000K/30W/40ST	30	4000	S	40	3200	107	-
SWAY	4000K/30W/50ST	30	4000	S	50	3200	107	-
SWAY	4000K/40W/20ST	40	4000	S	20	3500	88	-
SWAY	4000K/40W/30ST	40	4000	S	30	3900	98	-
SWAY	4000K/40W/40ST	40	4000	S	40	3900	98	-
SWAY	4000K/40W/50ST	40	4000	S	50	3900	98	-
SWAY	3000K/20W/20ST	20	3000	S	20	2000	100	-
SWAY	3000K/20W/30ST	20	3000	S	30	2200	110	-
SWAY	3000K/20W/40ST	20	3000	S	40	2200	110	-
SWAY	3000K/20W/50ST	20	3000	S	50	2200	110	-
SWAY	3000K/30W/20ST	30	3000	S	20	2750	92	-
SWAY	3000K/30W/30ST	30	3000	S	30	3000	100	-
SWAY	3000K/30W/40ST	30	3000	S	40	3000	100	-
SWAY	3000K/30W/50ST	30	3000	S	50	3000	100	-
SWAY	3000K/40W/20ST	40	3000	S	20	3300	83	-
SWAY	3000K/40W/30ST	40	3000	S	30	3700	93	-
SWAY	3000K/40W/40ST	40	3000	S	40	3700	93	-
SWAY	3000K/40W/50ST	40	3000	S	50	3700	93	-
SWAY	4000K/20W/20ST/DA	20	4000	S	20	2100	105	DALI
SWAY	4000K/20W/30ST/DA	20	4000	S	30	2350	118	DALI
SWAY	4000K/20W/40ST/DA	20	4000	S	40	2350	118	DALI
SWAY	4000K/20W/50ST/DA	20	4000	S	50	2350	118	DALI
SWAY	4000K/30W/20ST/DA	30	4000	S	20	2900	97	DALI
SWAY	4000K/30W/30ST/DA	30	4000	S	30	3200	107	DALI
SWAY	4000K/30W/40ST/DA	30	4000	S	40	3200	107	DALI
SWAY	4000K/30W/50ST/DA	30	4000	S	50	3200	107	DALI
SWAY	4000K/40W/20ST/DA	40	4000	S	20	3500	88	DALI
SWAY	4000K/40W/30ST/DA	40	4000	S	30	3900	98	DALI
SWAY	4000K/40W/40ST/DA	40	4000	S	40	3900	98	DALI
SWAY	4000K/40W/50ST/DA	40	4000	S	50	3900	98	DALI
SWAY	3000K/20W/20ST/DA	20	3000	S	20	2000	100	DALI
SWAY	3000K/20W/30ST/DA	20	3000	S	30	2200	110	DALI
SWAY	3000K/20W/40ST/DA	20	3000	S	40	2200	110	DALI
SWAY	3000K/20W/50ST/DA	20	3000	S	50	2200	110	DALI
SWAY	3000K/30W/20ST/DA	30	3000	S	20	2750	92	DALI
SWAY	3000K/30W/30ST/DA	30	3000	S	30	3000	100	DALI
SWAY	3000K/30W/40ST/DA	30	3000	S	40	3000	100	DALI
SWAY	3000K/30W/50ST/DA	30	3000	S	50	3000	100	DALI

CODE	P	T _c					DALI
------	---	----------------	--	--	--	--	------

		[W]	[K]		[°]	[lm]	[lm/W]	
SWAY	3000K/40W/20ST/DA	40	3000	S	20	3300	83	DALI
SWAY	3000K/40W/30ST/DA	40	3000	S	30	3700	93	DALI
SWAY	3000K/40W/40ST/DA	40	3000	S	40	3700	93	DALI
SWAY	3000K/40W/50ST/DA	40	3000	S	50	3700	93	DALI

Całkowity strumień świetlny oprawy zmierzony za kloszem przy temp. otoczenia 25°C. Tolerancja strumienia świetlnego +/- 10%. Pomiary fotometryczne zostały wykonane zgodnie z wymaganiami normy PN-EN13032. / The total luminous flux of the luminaire measured diffuser 25°C. Luminous flux tolerance +/- 10%. Photometric measurement were examined in accordance with the PN-EN13032 system. / Gesamtlichtstrom der Leuchte, gemessen hinter der Abdeckung 25°C. Lichtstrom-Toleranz +/- 10%. Photometrische Messungen wurden nach PN-EN13032 Norm geprüft.

FOTOMETRIA / PHOTOMETRY / PHOTOMETRIE:

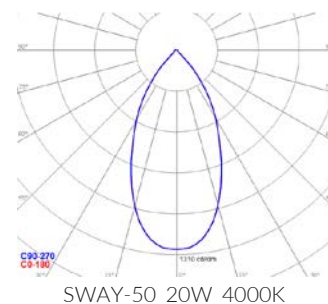
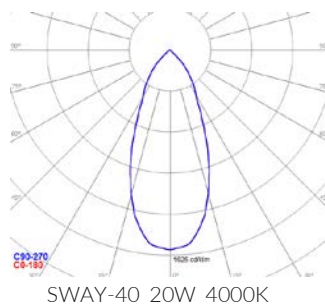
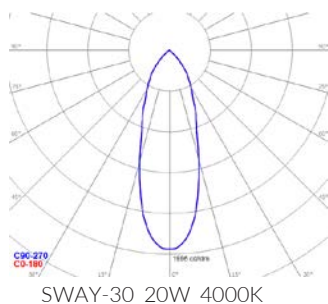
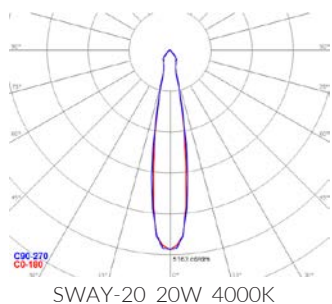

WYMIARY / DIMENSIONS / MASSE:

CODE			
	ø [mm]	H [mm]	[kg]
SWAY	168	100	

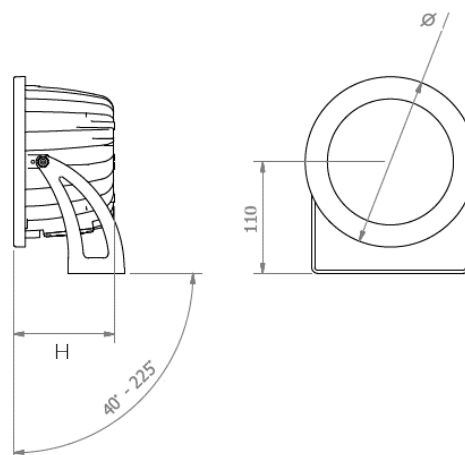

W związku z ciągłym rozwojem produktów zastrzegamy sobie prawo do wprowadzania zmian konstrukcyjnych w oprawach oraz aktualizowania parametrów.
 Due to continuous product development, we reserve the right to introduce structural changes in the fixtures and to update their parameters.
 Aufgrund der ständigen Produktentwicklung behalten wir uns das Recht vor, technische Änderungen und Aktualisierung von Parametern an Leuchten vorzunehmen.

Data aktualizacji / Revision Date / Datum der letzten Aktualisierung: 23.01.2017

LEGENDA / LEGENDA / LEGENDA:

	Deklaracja zgodności Declaration of conformity EG-Konformitätserklärung		Klasa ochronności I Protection class I Schutzklasse I		Napięcie zasilania Power supply Speisespannung
	Źródło światła LED LED source LED Quelle		Klasa efektywności energetycznej Energy efficiency class Energieeffizienzklasse		Dyrektywa RoHS The RoHS Directive RoHS Richtlinie
	Wymiary montażowe Mounting dimensions Montagemaße		Stopień szczelności IP IP protection marking Schutzklasse IP		Atest higieniczny PZH Hygiene certificate of the NIH Attest von Polnischer Hygieneanstalt
	Kod produktu Code Artikelnummer		Rodzaj klosza Cover Abdeckung		Moc oprawy Luminaire power Leistung der Leuchte
	Kąt rozsyłu światłości Light distribution angle Winkel der Lichtverteilung		Wymiary Dimensions Masse		Temperatura barwowa Color temperature Farbtemperatur
	Strumień świetlny Luminous flux Lichtstrom		Skuteczność świetlna Luminous efficiency Lichtausbeute der Leuchte		System sterowania DALI DALI control system Steuersystem DALI
	Kolor oprawy Luminaire color Leuchte Farbe		Waga Weight Gewicht		